

Use & Care Manual

With Installation Instructions for the Installer



Side Inlet Gas - FVIR Certified Water Heaters

For Manufactured Housing

The purpose of this manual is twofold: one, to provide the installer with the basic directions and recommendations for the proper installation and adjustment of the water heater; and two, for the owner-operator, to explain the features, operation, safety precautions, maintenance and troubleshooting of the water heater. This manual also includes a parts list.

It is very important that all persons who are expected to install, operate or adjust this water heater read the instructions carefully so they may understand how to perform these operations. If you do not understand these instructions or any terms within it, seek professional assistance.

Any questions regarding the operation, maintenance, service or warranty of this water heater should be directed to the seller from whom it was purchased. If additional information is required, refer to the section on "If You Need Service."

Do not destroy this manual. Please read carefully and keep in a safe place for future reference.



Recognize this symbol as an indication of Important Safety Information!



California Proposition 65 Warning: This product contains chemicals known to the State of California to cause cancer, birth defects or other reproductive harm.



WARNING: If the information in these instructions is not followed exactly, a fire or explosion may result causing property damage, personal injury or death.

▲ FOR YOUR SAFETY!

- Do not store or use gasoline or other flammable vapors or liquids or other combustible materials in the vicinity of this or any other appliance. To do so may result in an explosion or fire.
- **WHAT TO DO IF YOU SMELL GAS**
 - Do not try to light any appliance.
 - Do not touch any electrical switch; Do not use any phone in your building.
 - Immediately call your gas supplier from a neighbor's phone. Follow the gas supplier's instructions.
- If you cannot reach your gas supplier, call the fire department.
- Do not return to your home until authorized by the gas supplier or fire department.
- Improper installation, adjustment, alteration, service or maintenance can cause property damage, personal injury, or death. Refer to this manual. Installation and service must be performed by a qualified installer, service agency or the gas supplier.



Safety Information

Safety Precautions 3-6

LP Gas Models 5

Installation Instructions

Location 7

Water Supply Connections . 10

Gas Supply 12

Heat Traps 13

Pipe Insulation 13

Installation Checklist 15

Operating Instructions

Lighting Instructions 16

Water Temperature 17, 18

Care and Cleaning

Draining 19

Maintenance 19

Burner Inspection 20

Extended Shut-Down 20

Troubleshooting Tips

Before You Call

For Service 21, 22

Customer Service

Parts List 23

Conversion Instructions . 24-27

If You Need Service 28



FOR YOUR RECORDS

Write the model and serial numbers here:

You can find them on a label on the appliance.

Staple sales slip or cancelled check here.

Proof of the original purchase date is needed to obtain service under the warranty.



READ THIS MANUAL

Inside you will find many helpful hints on how to use and maintain your water heater properly. A little preventive care on your part can save you time and money over the life of your water heater.

You'll find many answers to common problems in the Troubleshooting Guide. If you review the chart of Troubleshooting Tips first, you may not need to call for service.



READ THE SAFETY INFORMATION

Your safety and the safety of others are very important. There are many important safety messages in this manual and on your appliance. Always read and obey all safety messages.

 **This is the safety alert symbol. Recognize this symbol as an indication of Important Safety Information!**
This symbol alerts you to potential hazards that can kill or hurt you and others.

All safety messages will follow the safety alert symbol and either the word "DANGER", "WARNING", "CAUTION" or "NOTICE".

These words mean:

 **DANGER** **An imminently hazardous situation that will result in death or serious injury.**

 **WARNING** **A potentially hazardous situation that could result in death or serious injury and/or damage to property.**

 **CAUTION** **A potentially hazardous situation that may result in minor or moderate injury.**

NOTICE: **Attention is called to observe a specified procedure or maintain a specific condition.**

IMPORTANT SAFETY INFORMATION

READ ALL INSTRUCTIONS BEFORE USING

Be sure to read and understand the entire Use and Care Manual before attempting to install or operate this water heater. It may save you time and money. Pay particular attention to the Safety Instructions. Failure to follow these warnings could result in serious bodily injury or death. Should you have problems understanding the instructions in this manual, or have any questions, STOP, and get help from a qualified service technician, or the local gas utility.

DANGER!

INSTALL THE DRAFT HOOD AND PROPERLY VENT THE WATER HEATER...



Failure to install the draft hood and properly vent the water heater to the outdoors as outlined in the Venting Section of the Installation Instructions in this manual can result in unsafe operation of the water heater. To avoid the risk of fire, explosion, or asphyxiation from carbon monoxide, never operate this water heater unless it is properly vented and has an adequate air supply for proper operation. Be sure to inspect the vent system for proper installation at initial start-up; and at least annually thereafter. Refer to the Care and Cleaning section of this manual for more information regarding vent system inspection.

WARNING!



Gasoline, as well as other flammable materials and liquids which include but not limited to (adhesives, solvents, paint thinners etc.), and the vapors they produce are extremely dangerous. DO NOT handle, use or store gasoline or other flammable or combustible materials anywhere near or in the vicinity of a water heater or any other appliance. Be sure to read and follow warning label pictured below and other labels on the water heater, as well as the warnings printed in this manual. Failure to do so can result in property damage, bodily injury or death.

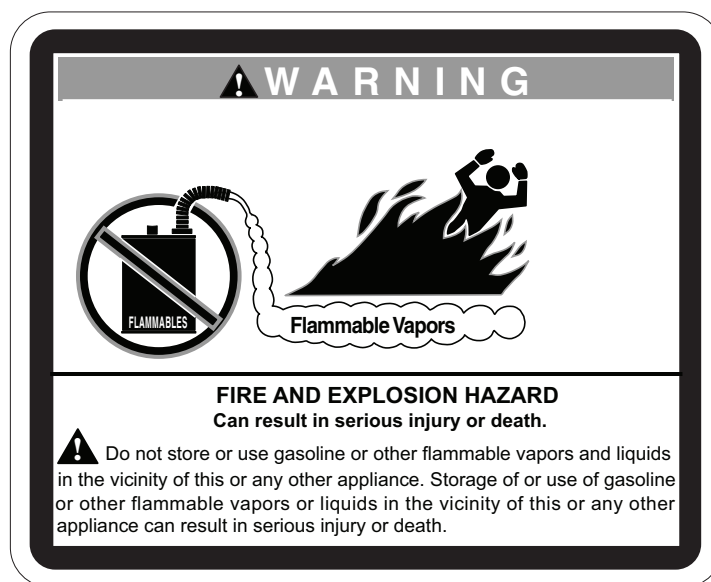

IMPORTANT SAFETY INFORMATION READ ALL INSTRUCTIONS BEFORE USING



! DANGER!

WATER TEMPERATURE SETTING

Safety and energy conservation are factors to be considered when selecting the water temperature setting of a water heater's gas control. Water temperatures above 125°F can cause severe burns or death from scalding. Be sure to read and follow the warnings outlined on the label pictured below. This label is also located on the water heater.

DANGER

Water temperature over 125° F can cause severe burns instantly or death from scalds.

Children, disabled and elderly are at highest risk of being scalded.

See instruction manual before setting temperature at water heater.

Feel water before bathing or showering.

Temperature limiting valves are available, see manual.

NOTICE: Mixing valves are recommended for reducing point of use water temperature by mixing hot and cold water in branch water lines. It is recommended that a mixing valve complying with the Standard for Temperature Actuated Mixing Valves for Hot Water Distribution Systems, ASSE 1017 be installed. See page 16 & 17 for more details and contact a licensed plumber or the local plumbing authority for further information.

Time/Temperature Relationship in Scalds

Water Temperature	Time To Produce a Serious Burn
120°F	More than 5 minutes
125°F	1½ to 2 minutes
130°F	About 30 seconds
135°F	About 10 seconds
140°F	Less than 5 seconds
145°F	Less than 3 seconds
150°F	About 1½ seconds
155°F	About 1 second

Table courtesy of Shriners Burn Institute

The chart shown above may be used as a guide in determining the proper water temperature for your home.

! DANGER: Households with small children, disabled, or elderly persons may require a 120°F or lower gas control (thermostat) setting to prevent contact with “HOT” water.

Maximum water temperatures occur just after the burner has shut off. To find water temperature being delivered, turn on a hot water faucet and place a thermometer in the water stream and read the thermometer. (See page 16 and 17 for more details.)

The temperature of the water in the heater can be regulated by setting the temperature dial on the front of the gas control (thermostat). To comply with safety regulations the gas control (thermostat) was set at its lowest setting before the water heater was shipped from the factory.

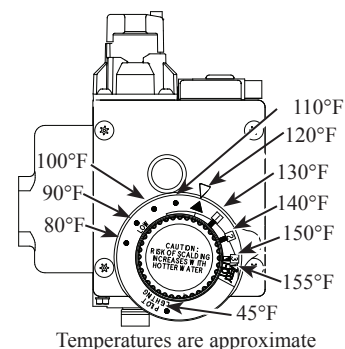

Temperatures are approximate

The illustration at the left details the approximate water temperature for each mark on the Gas Control (Thermostat) Temperature Dial.

! DANGER: Hotter water increases the potential for Hot Water SCALDS.



! DANGER!

LIQUEFIED PETROLEUM (LP - PROPANE OR BUTANE) AND NATURAL GAS MODELS

LP and Natural gas have an odorant added to aid in detecting a gas leak. Some people may not physically be able to smell or recognize this odorant. If you are unsure or unfamiliar with the smell of LP or natural gas, ask the gas supplier. Other conditions, such as “odorant fade”, which causes the odorant to diminish in intensity, can also hide or camouflage a gas leak.

- This water heater is supplied with a thermostatic gas valve that is convertible to LP from natural gas. Be sure to read and carefully follow the Conversion Instructions included in this manual when converting the valve from one type of gas to another.
- After conversion, be certain that the gas supplied to the heater is the type that the valve has been converted for (LP for heaters converted to LP use, and natural gas for heaters converted to natural gas use). This water heater will not operate safely if connected to a fuel type other than the one the gas valve is converted for.
- LP gas must be used with great caution. It is heavier than air and will collect first in lower areas making it hard to detect at nose level.
- Before attempting to light the water heater, make sure to look and smell for gas leaks. Use a soapy solution to check all gas fittings and connections. Bubbling at a connection indicates a leak that must be corrected. When smelling to detect an LP leak, be sure to sniff near the floor also.
- Gas detectors are recommended in LP and natural gas applications and their installation should be in accordance with the manufacturer’s recommendations and/or local laws, rules, regulations or customs.
- It is recommended that more than one method, such as soapy solution, gas detectors, be used to detect leaks in LP gas applications.

! DANGER: If a gas leak is present or suspected:

- **DO NOT** attempt to find the cause yourself.
- **DO NOT** try to light any appliance.
- **DO NOT** touch any electrical switch.
- **DO NOT** use any phone in your building.
- Leave the house immediately and make sure your family and pets leave also.
- Leave the doors open for ventilation and contact the gas supplier, a qualified service agency or the fire department.
- Stay away from the house (or building) until the service call has been made, the leak is corrected and a qualified agency has determined the area to be safe.

IMPORTANT SAFETY INFORMATION

READ ALL INSTRUCTIONS BEFORE USING

WARNING!

For your safety, the information in this manual must be followed to minimize the risk of fire or explosion, electric shock, or to prevent property damage, personal injury, or loss of life.



FOR INSTALLATIONS IN THE STATE OF CALIFORNIA

California Law requires that residential water heaters must be braced, anchored or strapped to resist falling or horizontal displacement due to earthquake motions. For residential water heaters up to 52-gallon capacity, a brochure with generic earthquake bracing instructions can be obtained from: Office of the State Architect, 1102 Q Street, Suite 5100, Sacramento, CA 95814 or you may call 916-445-8100 or ask a water heater dealer.

However, applicable local codes shall govern installation. For residential water heaters of a capacity greater than 52 gallons, consult the local building jurisdiction for acceptable bracing procedures.



SAFETY PRECAUTIONS

Have the installer show you the location of the gas shut-off valve and how to shut it off if necessary. Turn off the manual shut-off valve if the water heater has been subjected to overheating, fire, flood, physical damage or if the gas supply fails to shut off.

- Read this manual entirely before installing or operating the water heater.
- Use this appliance only for its intended purpose as described in this Use and Care Manual.
- Be sure your appliance is properly installed in accordance with local codes and the provided installation instructions.
- **DO NOT** attempt to repair or replace any part of your water heater unless it is specifically recommended in this manual. All other servicing should be referred to a qualified technician.



READ AND FOLLOW THIS SAFETY INFORMATION CAREFULLY.

SAVE THESE INSTRUCTIONS

Installing the water heater

The installation of this water heater must be in accordance with the **Manufactured Home Construction and Safety Standard (Title 24, CFR; Part 3280)** and the following instructions; instructions supplied with the roof jack assembly, local codes, and utility company requirements governing the installation of water heaters in manufactured homes (mobile homes) and/or in the absence of local codes, the latest edition of **The National Fuel Gas Code, ANSI Z223.1/NFPA 54.**

Location

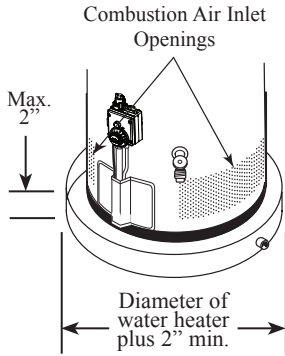

The auxiliary drain pan installation **MUST** conform to local codes.

CAUTION: DO NOT subject the water heater to any water distribution system air pressure test. The water heater should either be isolated with valves at the inlet and outlet water connections or disconnected during the test. Failure to properly isolate the water heater during an air pressure test presents a hazard to life and property. With a water pressure test the water heater need not be isolated.

WARNING: Combustible construction refers to adjacent walls and ceilings and should not be confused with combustible or flammable products and materials. Combustible and/or flammable products and materials should never be stored in the vicinity of this or any gas appliance.

CAUTION: Provisions should be made so that in the event the water heater or one of its fittings were to leak, the resulting flow of water will not cause damage to the manufactured home.

This water heater must be installed within an enclosure so as to separate the water heater's combustion and venting system from the interior atmosphere of the manufactured home.

All air for combustion must be obtained from the outside atmosphere, and the products of combustion (flue gases) must be discharged directly to the outside atmosphere through the gas vent roof jack assembly. There must not be any door or other opening into the water heater enclosure from the inside of the manufactured home.

Refer to installation methods A as shown on page 9 of this manual. The water heater enclosure access panel (door) must be in the outside wall of the manufactured home. Any opening for piping must be sealed. Minimum ceiling height within enclosure is 6 ft 6 in.

The water heater should not be located in an area where leakage from the tank or connections will result in damage to the area adjacent to the heater or to lower floors of the structure.

When such areas cannot be avoided it is recommended that a suitable drain pan, adequately drained, must be installed under the water heater.

The pan must not restrict air flow to the combustion air inlet openings (perforation openings) located around the lower perimeter of the water heater.

Drain pan kits are available from the store where the water heater was purchased, or any water heater distributor.

Make certain the floor underneath the water heater is strong enough to sufficiently support the weight of the water heater once it is filled with water.

A gas fired water heater or any other appliance should not be installed in a space where liquids which give off flammable vapors are to be used or stored. Such liquids include gasoline, LP gas (butane or propane), paint or adhesives and their thinners, solvents or removers.

When installed in a closet, **DO NOT** block or obstruct any of the combustion air inlet openings located around the perimeter of the water heater. A minimum of 1 in. is required between these combustion air inlet openings and any obstruction.

Because of natural air movement in a room or other enclosed space, flammable vapors can be carried some distance from where liquids which give off flammable vapors are to be used or stored. The open flame of the water heater's pilot or main burner can ignite these vapors and create a shut down condition of the water heater which will not allow the water heater to ignite until examined by a Qualified Service Technician.

- Long hot water lines should be insulated to conserve water and energy.
- The water heater and water lines should be protected from exposure to freezing temperatures.
- Minimum clearance from combustible

Location	Front of Control*	Sides	Rear	Top**
Closet	3 in.	1 in.	0 in.	12 in.

construction:

* "Front" Clearance is measured from the gas control (thermostat) to the closet door.

** "Top" Clearance is measure from the jacket top of the water heater to the ceiling.

If the clearances stated on the Instruction/Warning Label, located on the front of the heater differ, install the water heater according to the clearances stated on the label.

- If the water heater is installed in an alcove or closet, the entire floor must be covered by a wood or metal panel. A minimum of 24 in. Clearance from the front and top should be available for adequate inspection and servicing.
- The water heater may be installed on combustible floors, but not directly on carpeting. If the water heater must be installed on carpeting, place a metal or wood panel beneath the water heater, extending beyond its full width and depth at least 3 in. in all directions.

NOTICE: For proper operation and maintenance, a minimum clearance of 1-1/2 in. must be provided from the combination temperature and pressure relief valve to any wall or object.

Installing the water heater

Installation Methods

- 1 Inspect shipment.** — Inspect the water heater for possible shipping damage.
- 2 Placement of water heater.** — Locate the water heater as desired, make certain the minimum clearances outlined in this manual are observed.
- 3 Combustion and ventilation air.** — Air for combustion and ventilation must not be supplied from occupied spaces of the mobile home. Select installation method "A" from page 9. **The air inlet must not be obstructed under any circumstances. Outside air is necessary for proper and safe operation of the water heater.**

Method A - Requires a minimum free area of 100 square inches outside fresh air opening in the outside access panel (door). Cut door opening commencing within 12" of the floor. Suggested protection for air opening is 1/4 " (minimum) mesh metal screen.

- 4 Gas vent roof jack.** — The roof jack is not supplied with the water heater as a component part. The roof jack must be one of the models listed in this manual, and marked as approved by Underwriters Laboratories, Inc. for use on manufactured homes (mobile homes).

(See Illustration on page 9) The Gas Vent Roof Jack Assembly (purchased separately) has a multi piece telescopic vent connector pipe consisting of an upper, center and lower section that must be pre-adjusted according to the following directions prior to final installation of the roof jack.

From the water heater location, measure the distance from the highest point on roof opening to the floor. Select correct size Roof Jack from Roof Jack Sizing Guide on Page 9, Dimension X. Remove the Roof Jack from its carton, and extend the center section of the inner most pipe to its maximum length by grasping the pipe and sliding the center section of pipe downward. Then extend the lower section of the inner pipe in the

same manner to its full extension. Silicone rubber sealing bands are provided and must be pulled down over the joints between the tubes to ensure a leak proof seal.

Apply a non-hardening mastic on the roof around the previously cut hole to form a weather tight seal with the roof flange of the Roof Jack Assembly. Insert the roof jack through the opening in roof from above, and fasten the flashing to the roof using the pre-punched holes in the flashing. (The roof flange adjusts to accommodate installation on a pitched roof, maximum allowable pitch is 5¹/₂-12. For roof pitches greater than 5¹/₂-12, the use of a "wedge" under the roof flange is acceptable provided it is sealed and secured.) Apply additional non-hardening mastic as required to complete the weather seal.

With Roof Jack in place and secured to the roof, insure that the line on the larger, outer tube of the Roof Jack, which is marked "INSTALL WITH THIS LINE BELOW CEILING" is located no less than 2 in. below the ceiling line and no less than six inches above the water heater. Refer to page 9.

Now extend the lower section of the vent connector pipe by grasping the center section of pipe, ensuring that the silicone rubber seal remains in position over the joint, and sliding the lower section of pipe downward, over the top of the draft hood. Complete the roof jack assembly by securing the roof jack to the draft hood with sheet metal screws. Secure the draft hood to the top pan with the sheet metal screws.

- 5 Securing the water heater.** — Secure the water heater using the provided metal straps to the top pan of the water heater and fasten the brackets to the adjacent walls on each side. Attach the straps above the bottom pan of the water heater, then fasten the straps to the adjacent wall on each side.

▲ NOTICE: An optional leg kit (SP20133) is available for replacement water heaters which draws air for combustion and ventilation from below the water heater. Leg kits are available from the store where the water heater was purchased or any water heater distributor.

▲ WARNING: If a drain pan is used it should have an opening to allow combustion air to allow combustion air. The joint around the drain pan and floor needs to be sealed with silicone to avoid any damage to floor in the event the water heater or one of its fittings leak.

▲ WARNING: Water Piping should be well insulated to prevent damage to pipes due to freezing.

ROOF JACK — This water heater is certified for use with one of the following:
AP12119B, AP12118B, AP12118C, AP12118D.

Additional information on other Rheem approved and certified roof jacks may be found at www.rheem.com under Product Categories, select Water Heating, scroll down left side of page and select Technical Bulletins, again on left side locate series #1500 Bulletins and select #1504.

NOTICE: Refer to Section 4, page 8 for additional requirements

METHOD A

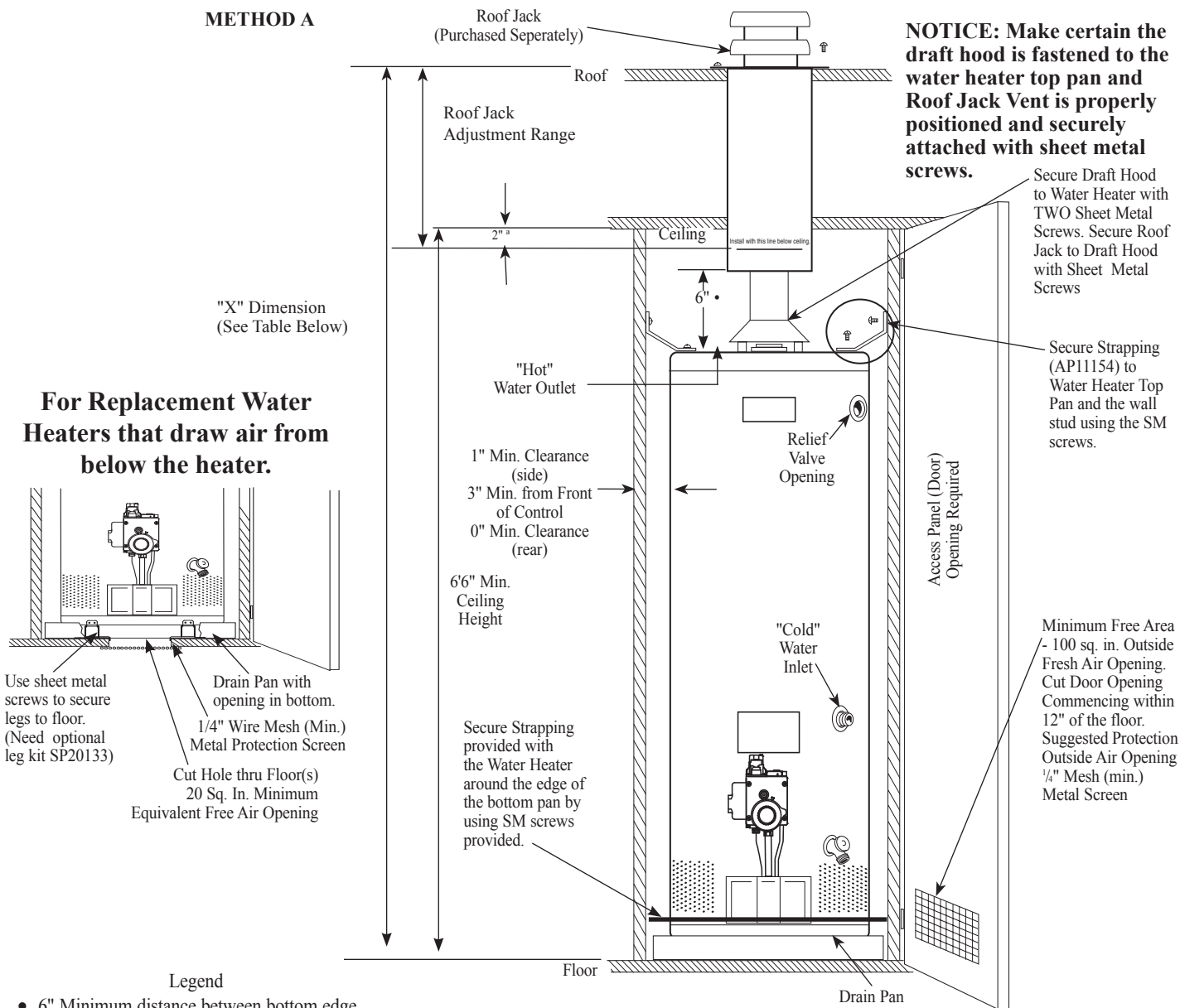

NOTICE: Make certain the draft hood is fastened to the water heater top pan and Roof Jack Vent is properly positioned and securely attached with sheet metal screws.

For Replacement Water Heaters that draw air from below the heater.

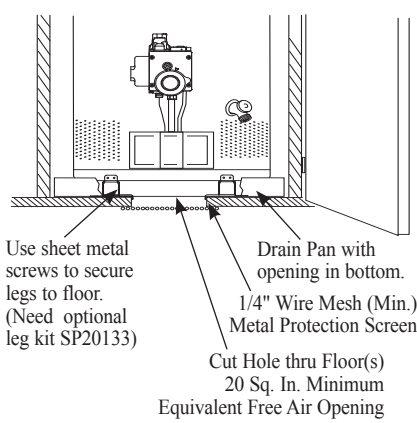

Use sheet metal screws to secure legs to floor. (Need optional leg kit SP20133)

Drain Pan with opening in bottom.

1/4" Wire Mesh (Min.) Metal Protection Screen

Cut Hole thru Floor(s) 20 Sq. In. Minimum Equivalent Free Air Opening

Legend

- 6" Minimum distance between bottom edge of the roof jack outer pipe and the top of the water heater.
- a 2" is minimum distance between ceiling and "Must be installed below ceiling" line on Roof Jack.

Roof Jack Sizing Table

Roof Jack Part No.	"X" Dimension (See Illustration)	Roof Jack Adjustment Range (See Illustration)
AP12118B*	98" Min./126" Max.	16" Min./ 32" Max.
AP12118C*	112" Min./154" Max.	30" Min./60" Max.
AP12118D*	130" Min./ 189" Max.	48" Min./95" Max.
AP12119B▲	94" Min./ 106" Max.	12"

* Adjustable Length Roof Jacks
▲ Fixed Length Roof Jacks

Figure A - Top View of closet.

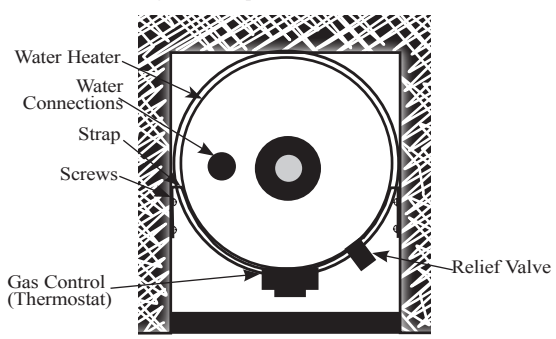

Installing the water heater

Thermal Expansion

Determine if a check valve exists in the inlet water line. Check with your local water utility company. It may have been installed in the cold water line as a separate back flow preventer, or it may be part of a pressure reducing valve, water meter or water softener. A check valve located in the cold water inlet line can cause what is referred to as a “closed water system”. A cold water inlet line with no check valve or back flow prevention device is referred to as an “open” water system.

As water is heated, it expands in volume and creates an increase in the pressure within the water system. This action is referred to as “thermal expansion”. In an “open” water system, expanding water which exceeds the capacity of the water heater flows back into the city main where the pressure is easily dissipated.

A “closed water system”, however, prevents the expanding water from flowing back into the main supply line, and the result of “thermal expansion” can create a rapid and dangerous

pressure increase in the water heater and system piping. This rapid pressure increase can quickly reach the safety setting of the relief valve, causing it to operate during each heating cycle. Thermal expansion, and the resulting rapid, and repeated expansion and contraction of components in the water heater and piping system can cause premature failure of the relief valve, and possibly the heater itself. Replacing the relief valve **will not** correct the problem!

The suggested method of controlling thermal expansion is to install an expansion tank in the cold water line between the water heater and the check valve. The expansion tank is designed with an air cushion built in that compresses as the system pressure increases, thereby relieving the over pressure condition and eliminating the repeated operation of the relief valve. Other methods of controlling thermal expansion are also available. Contact your installing contractor, water supplier or plumbing inspector for additional information regarding this subject.

IMPORTANT: DO NOT apply heat to the HOT or COLD water connections. If sweat connections are used, sweat tubing to adapter before fitting adapter to the cold water connections on heater. Any heat applied to the cold water supply fittings will permanently damage the dip tube.

Water Supply Connections

Refer to the illustration below for suggested typical installation. The installation of unions or flexible copper connectors is recommended on the hot and cold water connections so that the water heater may be easily disconnected

for servicing if necessary. The HOT and COLD water connections are clearly marked and are 3/4 in. NPT on all models. Install a shut-off valve in the cold water line near the water heater.

Typical Installation

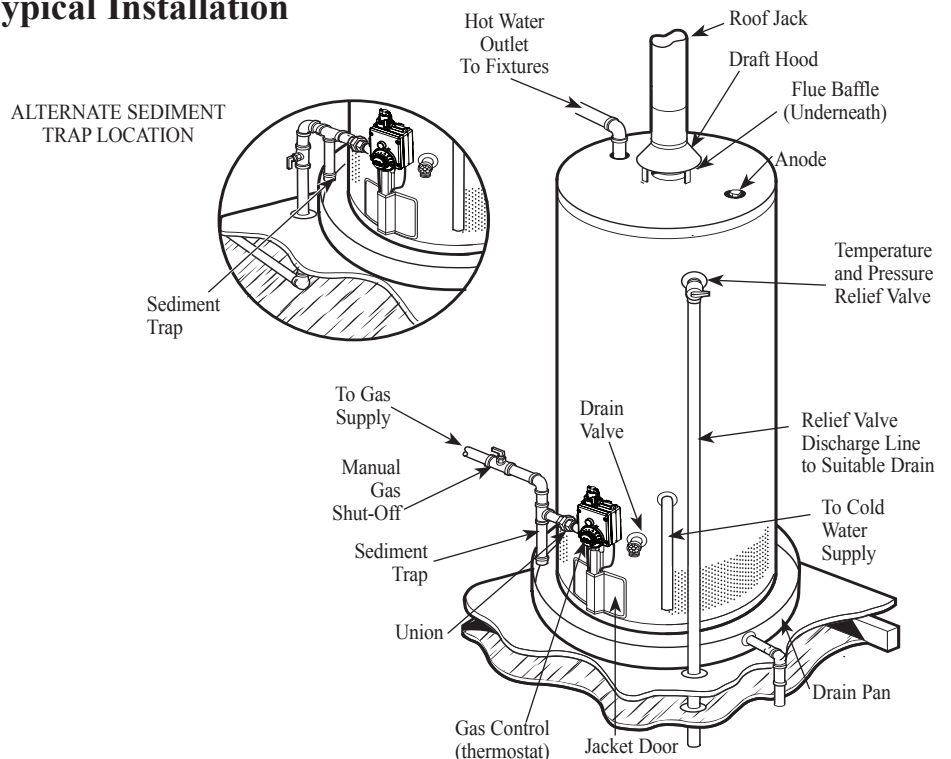

NOTICE: The National Fuel Gas Code (NFGC) mandates a manual gas shut-off valve: See (NFGC) for complete instructions. Local codes or plumbing authority requirements may vary from the instructions or diagrams provided and take precedent over these instructions.

A new combination temperature and pressure relief valve, complying with the Standard for Relief Valves for Hot Water Supply Systems, ANSI Z21.22, is supplied and must remain in the opening provided and marked for the purpose on the water heater. No valve of any type should be installed between the relief valve and the tank. Local codes shall govern the installation of relief valves.

Relief Valve

The pressure rating of the relief valve must not exceed 150 psi, the maximum working pressure of the water heater as marked on the rating plate.

The Btuh rating of the relief valve must equal or exceed the Btuh input of the water heater as marked on its rating plate.

Position the outlet of the relief valve above a suitable open drain to eliminate potential water damage. Piping used should be of a type

approved for hot water distribution.

The discharge line must be no smaller than the outlet of the valve and must pitch downward from the valve to allow complete drainage (by gravity) of the relief valve and discharge line.

The end of the discharge line should not be threaded or concealed and should be protected from freezing. No valve of any type, restriction, or reducer coupling should be installed in the discharge line.

▲WARNING: The tank must be full of water before heater is turned on. The water heater warranty does not cover damage or failure resulting from operation with an empty or partially empty tank.

To Fill the Water Heater

Make certain that the drain valve is closed, then open the shut-off valve in the cold water supply line.

Open each hot water faucet slowly to allow the air to vent from the water heater and piping.

A steady flow of water from the hot water faucet(s) indicates a full water heater.

Condensation

Condensation can form on the tank when it is first filled with water. Condensation might also occur with a heavy water draw and very cold inlet water temperatures.

Drops of water falling on the burner can produce a sizzling or pinging sound.

This condition is not unusual, and will disappear after the water becomes heated. If, however, the condensation continues, examine the piping and fittings for possible leaks.

▲WARNING: Failure to install a water heater suitable for the altitude at the location it is intended to serve, can result in improper operation of the appliance resulting in property damage and/or, producing carbon monoxide gas, which could result in personal injury, or death.

High Altitude

Ratings of gas appliances are based on sea level operation.

This water heater is suitable and certified for use at high altitude. Refer to the altitude label on the water heater for maximum allowable installation altitude.

Please contact your local distributor or place of purchase for a high altitude model.

Installing the water heater

Gas Supply

Check the markings on the water heater's rating plate to be certain the type of gas being furnished corresponds to that for which the water heater is built. The water heater can be converted from natural gas to LP or vice versa. See the Conversion Instructions section of this manual.

The branch gas supply line to the water heater should be clean 1/2 in. black steel pipe or other approved gas piping material.

A union or ANSI design certified semi-rigid or flexible gas appliance connector should be installed in the gas line close to the water heater. The HUD code should be followed for installation and location of a manual shutoff valve.

If flexible connectors are used, the maximum length shall not exceed 36 in. (91.4 cm) and must meet the requirements in ANSI Z21.24 - Connectors for Gas Appliances.

Compound used on the threaded joints of the gas piping must be of the type resistant to the action of LP gas. Use compound

sparingly on male threads only.

Where a sediment trap is not incorporated as part of the appliance, a sediment trap shall be installed downstream of the equipment shutoff valve as close to the inlet of the appliance as practical at the time of the appliance installation. The sediment trap shall be either a tee fitting with a capped nipple in the bottom outlet or other device recognized as an effective sediment trap.

DO NOT use excessive force (over 31.5 ft lbs.) in tightening the pipe joint at the gas control (thermostat) inlet, particularly if teflon pipe compound is used, as the valve body may be damaged.

The inlet gas pressure to the water heater must not exceed 14 in. w.c. for natural gas, or 14 in. w.c. for LP gas. For purposes of input adjustment, the minimum inlet gas pressure (with main burner on) is shown on the water heater rating plate. If high or low gas pressures are present, contact your gas supplier for correction.

▲WARNING:
Never use an open flame to test for gas leaks, as property damage, personal injury, or death could result.

Leak Testing

The water heater and its gas connections must be leak tested at normal operating pressures before it is placed in operation.

- 1 Turn on the manual gas shut-off valve near the water heater.
- 2 Use a soapy water solution to test for

leaks at all connections and fittings. Bubbles indicate a gas leak that must be corrected.

The factory connections to the gas control (thermostat) should also be leak tested after the water heater is placed in operation.

Pressure Testing the Gas Supply System

The water heater and its manual gas shut-off valve must be disconnected from the gas supply piping system during any pressure testing of that system at test pressures in excess of 1/2 psi (3.5 kPa).

The water heater must be isolated from the gas piping system by closing the manual gas shut-off valve during any pressure testing of the gas supply piping system at test pressures equal to or less than 1/2 psi (3.5 kPa).

Hot and Cold Pipe Insulation Installation

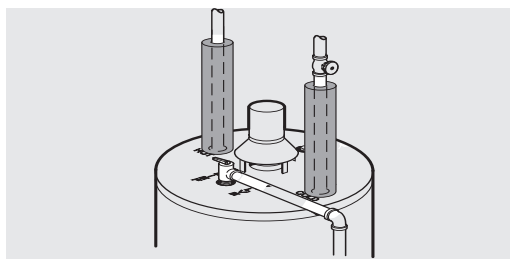

Typical vertical piping arrangement

For increased energy efficiency, some water heaters have been supplied with two 24 in. sections of pipe insulation.

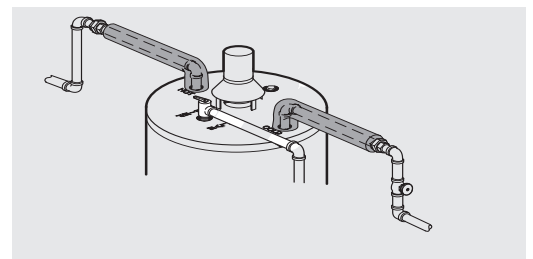

Typical horizontal piping arrangement

Please install the insulation, according to the illustrations above, that best meets your requirements.

T&P Insulation Installation

For increased energy efficiency, this water heater has been supplied with a 2 3/8 in. section of T&P insulation. Please install the insulation as shown below.

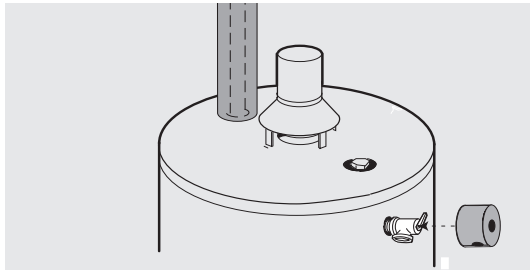

Typical Side Connect T & P Arrangement.

Slip the insulation cover over the T&P Valve through the center hole and align the hole in the side with the opening of the T&P Valve.

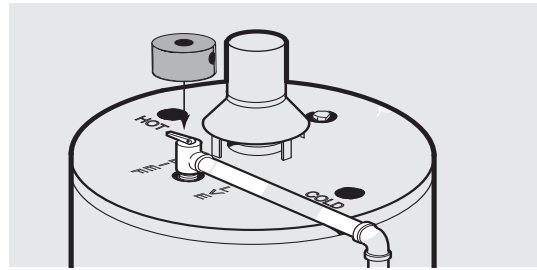

Typical Top Connect T & P Arrangement.

Ensure the T&P Valve opening is not obstructed by the insulation.

Heat Trap

For increased energy efficiency, some water heaters have been supplied with factory installed 3/4 in. NPT heat traps in the hot outlet line and cold water inlet line.

These heat traps may require a minimum of one (1) 90° 3/4 in. NPT elbow and may require an additional 90° 3/4 in. NPT elbow or a 3/4 in. coupling depending on your installation needs. See illustration of nipples and heat traps on page 22.

During Installation of this water heater

DO

- DO** check inlet gas pressure to ensure that it is within the range specified on the rating plate.
- DO** provide adequate air for combustion and ventilation as discussed in the Use and Care Manual and the National Fuel Gas Code.
- DO** maintain proper clearances to combustibles as specified on the Instruction/Warning Label.
- DO** ensure that the venting system complies with the guidelines found in the Use and Care Manual and National Fuel Gas Code.
- DO** contact a qualified service technician if the pilot or main burner will not stay lit. The burner chamber is designed to be sealed utilizing a gasket and tamper resistant screws.

DON'T

- DON'T** block or restrict Combustion Air Inlet Openings located around the lower portion of the water heater jacket.
- DON'T** remove the Burner Access Door unless absolutely necessary. This should only be done by a qualified service technician. A new burner access door gasket must be installed on any burner access door that has been removed.
- DON'T** install this water heater where standing water may occur. The base of the water heater is meant to be mounted on a dry surface.
- DON'T** operate the water heater if the sight glass or pilot assembly grommet is damaged or broken.

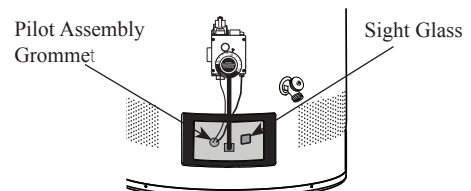

Installation Checklist

A. Water Heater Location

- Water heater securely anchored.
 - Indoors and protected from freezing temperatures.
 - Proper clearance from combustible surfaces observed and water heater not installed on carpeted floor.
 - Sufficient fresh air supply for proper operation of water heater.
 - Air supply free of corrosive elements and flammable vapors.
 - Provisions made to protect area from water damage.
 - Sufficient room to service heater.
 - Combustible materials, such as clothing, cleaning materials, rags, etc. clear of the base of the heater.
 - Clearances from combustion air inlet openings observed (see page 7).
-

B. Water Supply

- Water heater completely filled with water.
 - Air purged from water heater and piping.
 - Water connections tight and free of leaks.
-

C. Gas Supply

- Gas line equipped with shut-off valve, union and sediment trap.
 - Approved pipe joint compound used.
 - Soap and water solution used to check all connections and fittings for possible gas leak.
 - Gas Company inspected installation (if required).
 - After conversion, be certain the gas supplied to the heater is the type the valve has been converted for (LP for heaters converted to LP use, and natural gas for heaters converted to natural gas use).
-

D. Relief Valve

- Temperature and Pressure Relief Valve properly installed and discharge line run to open drain.
 - Discharge line protected from freezing.
-

E. Venting

- Flue baffle properly hung in top of heater's flue.
- Draft hood properly installed.
- Gas Vent Roof Jack properly installed.

Lighting the water heater

Before operating this water heater, be sure to read and follow the instructions on the label pictured below and all other labels on the water heater, as well as the warnings printed in this manual. Failure to do so can result in unsafe operation of the water heater resulting in property damage, personal injury, or death. Should you have any problems reading or following the instructions in this manual, STOP, and get help from a qualified person.

FOR YOUR SAFETY READ BEFORE OPERATING

▲ WARNING: If you do not follow these instructions and the Use & Manual instructions exactly, a fire or explosion may result causing property damage, personal injury or loss of life.

- A. This appliance has a pilot which is lit by a piezo-electric spark gas ignition system. Do **NOT** open the inner door of this appliance and try to light the pilot by hand!
- B. **BEFORE LIGHTING** smell all around the appliance area for gas. Be sure to smell next to the floor because some gas is heavier than air and will settle on the floor.
WHAT TO DO IF YOU SMELL GAS
 - Do not try to light any appliance.
 - Do not touch any electric switch; do not use any phone in your building.
 - Immediately call your gas supplier from a neighbor's phone. Follow the gas supplier's instructions.
 - If you cannot reach your gas supplier, call the fire department.
- C. Use **only your hand** to turn the gas control knob. Never use tools. If the knob will not turn by hand, don't try to repair it; call a qualified service technician. Force or attempted repair may result in a fire or explosion.
- D. Do not use this appliance if any part has been under water. Immediately call a qualified installer or service agency to replace a flooded water heater. Do not attempt to repair the unit! It must be replaced!

LIGHTING INSTRUCTION

1. **STOP!** Read safety information above on this label.
2. Set the thermostat dial to the lowest setting by turning the thermostat dial clockwise ↻ until it stops. **DO NOT FORCE.**
3. Slightly depress the gas control knob and turn clockwise ↻ to "OFF" position. Note: Knob cannot be turned from "PILOT" position unless pushed down slightly. Do not use force.
4. Wait five (5) minutes to clear out any gas. If you smell any gas, **STOP!** follow "B" in the safety information above on this label. If you do not smell gas, go to the next step.
5. Remove the outer door from the water heater. Do not attempt to remove the inner door.
6. Locate the piezo-electric spark generator which is located on top of the combination gas control.
7. Turn the gas control knob counter-clockwise ↻ to the "PILOT" position.
8. Depress and hold the gas control knob all the way down. Immediately depress the piezo-electric spark generator button several times until the pilot is lit. The pilot flame can only be seen through the sight glass window located on the inner door.
9. Continue to hold down the gas control knob for about one (1) minute after the pilot is lit. If it goes out repeat steps 3 to 9.
 - If the gas control knob does not pop up when released, stop and immediately call your service technician or gas supplier.
 - If the pilot will not stay lit after several tries, turn the gas control knob clockwise ↻ to "OFF" and call your service technician or gas supplier.
10. Once the pilot flame is established replace the outer door.
11. Turn the gas control knob counter-clockwise ↻ to the "ON" position. Warning do not use gas control knob to regulate gas flow to burner.
12. Set the thermostat dial to desired setting by turning dial counter-clockwise. The preferred starting point for temperature setting is to align the two triangular pointers on the dial and control face.

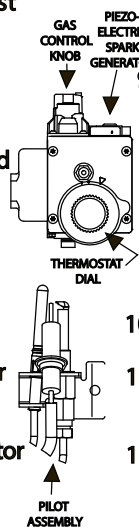

TO TURN GAS OFF TO THE APPLIANCE

1. Set the thermostat dial to the lowest setting by turning the thermostat dial clockwise ↻ until it stops. **DO NOT FORCE.**
2. Slightly depress the gas control knob and turn clockwise ↻ to "OFF POSITION". Note: Knob cannot be turned from "PILOT" position unless pushed down slightly. Do not use force.

Operating the water heater

▲ CAUTION: Hydrogen gas can be produced in a hot water system served by this water heater that has not been used for a long period of time (generally two weeks or more). **HYDROGEN GAS IS EXTREMELY FLAMMABLE!!** To dissipate such gas and to reduce risk of injury, it is recommended that the hot water faucet be opened for several minutes at the kitchen sink before using any electrical appliance connected to the hot water system. If hydrogen is present, there will be an unusual sound such as air escaping through the pipe as the water begins to flow. **DO NOT** smoke or use an open flame near the faucet at the time it is open.

Safety Precautions

- A** **DO** turn off manual gas shut-off valve if water heater has been subjected to over heating, fire, flood, physical damage or if the gas supply fails to shut off.
 - B** **DO NOT** turn on water heater unless it is completely filled with water.
 - C** **DO NOT** turn on water heater if cold water supply shut-off valve is closed.
 - D** **DO NOT** allow combustible materials such as newspaper, rags or mops to accumulate near water heater.
 - E** **DO NOT** store or use gasoline or other flammable vapors and liquids, such as adhesives or paint thinner, in vicinity of this or any other appliance. If such flammables must be used, open doors and windows for ventilation, and all gas burning appliances in the vicinity should be shut off including their pilot burners, to avoid vapors lighting.
- NOTICE:** Flammable vapors can be drawn by air currents from surrounding areas to the water heater.
- F** If there is any difficulty in understanding or following the Operating Instructions or the Care and Cleaning section, it is recommended that a qualified person or serviceman perform the work.

Water Temperature Setting

▲ DANGER: Hotter water increases the Potential for Hot Water SCALDS. Households with small children, disabled, or elderly persons may require a 120°F or lower gas control (thermostat) setting to prevent contact with HOT water.

The temperature of the water in the water heater can be regulated by setting the temperature dial on the front of the gas control (thermostat).

Safety and energy conservation are factors to be considered when selecting the water temperature setting of the water heater's gas control (thermostat). The lower the temperature setting, the greater the savings in energy and operating costs.

To comply with safety regulations, the gas control (thermostat) was set at its lowest setting before the water heater was shipped from the factory. The recommended starting point temperature is 120°F.

Water temperatures above 125°F can cause severe burns or death from

scalding. Be sure to read and follow the warnings outlined in this manual and on the label located on the water heater near the gas control (thermostat).

Mixing valves are recommended for reducing point of use water temperature by mixing hot and cold water in branch water lines. It is recommended that a mixing valve complying with the Standard for Temperature Actuated Mixing Valves for Hot Water Distribution Systems, ASSE 1017 be installed. See page 4 for more details and contact a licensed plumber or the local plumbing authority for further information.

The chart below may be used as a guide in determining the proper water temperature for your home.

Time/Temperature Relationship in Scalds

Water Temperature	Time To Produce a Serious Burn
120°F	More than 5 minutes
125°F	1½ to 2 minutes
130°F	About 30 seconds
135°F	About 10 seconds
140°F	Less than 5 seconds
145°F	Less than 3 seconds
150°F	About 1½ seconds
155°F	About 1 second

Table courtesy of Shriners Burn Institute

Operating the water heater

Water Temperature Setting

Maximum water temperatures occur just after the burner has shut off. To determine the water temperature, turn on a hot water faucet and place a thermometer in the water stream.

The reference mark ▲ on the rim of the temperature dial, represents an approximate water temperature of 120°F.

The reference Ⓐ or ① mark represents an approximate water temperature of 130°F.

Each reference mark above or below these points indicates an approximate change of 10°F.

To adjust the temperature, turn the temperature dial to an initial setting of 120°F.

A condition known as “stacking” or “layering” can occur when a series of short and frequent hot water draws are taken.

The hottest temperature water will be at the top of the tank, closest to the outlet pipe delivering hot water to the home.

Stacking can cause this top layer of water to be hotter than the water toward the bottom of the tank near the gas control (thermostat).

Therefore, always remember to test the water temperature with your hand before use and remember that hotter water increases the risk of scald injury.

Also, always supervise young children or others who are incapacitated.

The gas control (thermostat) is constructed with a built in safety shut-off device designed to shut off the gas supply to the burner if the pilot flame is extinguished for any reason.

The gas control (thermostat) is also equipped with a single use gas shut off device that will shut off the gas supply to the burner if the water heater exceeds normal operating temperatures. Refer to the (Before You Call For Service) section of this manual, or contact your dealer.

▲WARNING: Should overheating occur or the gas supply fail to shut off, turn off the manual gas valve to the appliance.

If the water heater has been subjected to fire, flood or physical damage, turn off the manual gas (shut-off) valve, and do not operate the water heater again until it has been checked by a qualified service technician.

NOTICE: Do not use this appliance if any part has been under water. Immediately call a qualified installer or service agency to replace a flooded water heater. Do Not attempt to repair the unit! It must be replaced.

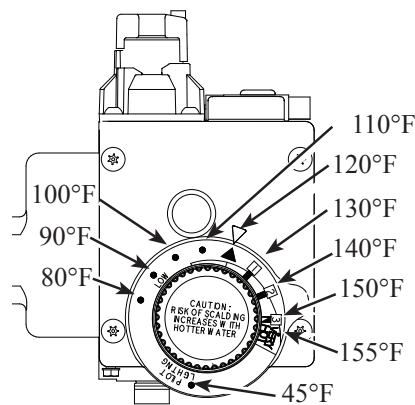

Temperature Dial

(Temperatures are approximate)

Care and cleaning of the water heater

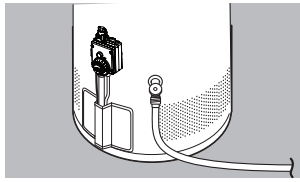

Draining the Water Heater

▲CAUTION: Shut off gas to the water heater using the gas control knob (thermostat) or manual shut-off valve before draining water.

▲DANGER: Before manually operating the temperature and pressure relief valve, make certain no one will be exposed to the hot water released by the valve. The water drained from the tank may be hot

enough to present a scald hazard and should be directed to a suitable drain to prevent injury or damage.

In order to drain the water heater, turn off the cold water supply. Open a hot water faucet or lift the handle on the relief valve to admit air to the tank.

Attach a garden hose to the drain valve on the water heater and direct the stream of water to a drain. Open the valve.

▲DANGER: Before manually operating the relief valve, make certain no one will be exposed to the danger of the hot water released by the valve. The water may be hot enough to create a scald hazard. The water should be released into a suitable drain to prevent injury or property damage.

▲DANGER: Hotter water increases the potential for Hot Water Scalds.

▲DANGER: Failure to perform the recommended Routine Preventative Maintenance can harm the proper operation of this water heater, which can cause carbon monoxide dangers, excessive hot water temperatures and other potentially hazardous conditions.

Routine Preventative Maintenance

Properly maintained, your water heater will provide years of dependable trouble-free service.

It is recommended that a periodic inspection of the gas control (thermostat), burner, relief valve, internal flue-way and venting system should be made by service personnel qualified in gas appliance repair.

It is suggested that a routine preventative maintenance program be established and followed by the user.

At least once a year, lift and release the lever handle on the temperature pressure relief valve, located near the top of the water heater, to make certain the valve operates freely. Allow several gallons to flush through the discharge line to an open drain.

NOTICE: If the temperature and pressure relief valve on the hot water heater discharges periodically, this may be due to thermal expansion in a closed water system. Contact the water supplier or your plumbing contractor on how to correct this. **DO NOT plug the relief valve outlet.**

A water heater's tank can act as a settling basin for solids suspended in the water. It is therefore not uncommon for hard water deposits to accumulate in the bottom of the tank. If allowed to accumulate, these solids can cover the gas control (thermostat)

sensors, causing the sensors to operate erratically. Because accumulated solids can prevent the gas control (thermostat) sensors from accurately reading the water temperature, the water at the fixture can be hotter than the gas control (thermostat) dial setting. It is suggested that a few quarts of water be drained from the water heater's tank every month to clean the tank of these deposits.

Rapid closing of faucets or solenoid valves in automatic water using appliances can cause a banging noise heard in a water pipe. Strategically located risers in the water pipe system or water hammer arresting devices can be used to minimize the problem.

The anode rod should be removed from the water heater's tank annually for inspection and replaced when more than 6 in. of core wire is exposed at either end of the rod.

Make sure the cold water supply is turned off before removing anode rod.

This water heater incorporates a combustion shut off device that shuts the operation of the water heater down if undesirable combustion conditions occur. Such as the presence of flammable vapors or blockage of the combustion air inlet openings. Please contact a Qualified Service Technician if this occurs.

Housekeeping

▲DANGER: Combustible materials, such as clothing, cleaning materials, or flammable liquids, etc., must not be placed against or next to the water heater.

Visually inspect pilot burner and relight if necessary.

To ensure sufficient ventilation and combustion air supply, proper clearances must be maintained.

When installed in a closet, **DO NOT** block or obstruct any of the combustion air inlet openings located around the perimeter of the water heater. A minimum of 1 in. is required between the combustion air inlet openings and any obstruction.

Care and cleaning of the water heater

Venting System Inspection

Make certain the draft hood is fastened to the water heater top pan and roof jack vent is properly positioned and securely attached with sheet metal screws.

If after inspection of the vent system you found soot or deterioration; call the local gas utility to correct the problem and clean the flue, or replace the flue, flue baffle, and venting system before resuming operation of the water heater.

Test for spillage at the draft hood relief opening after 5 minutes of burner operation. Use a flame of a match or candle or smoke.

Burner Inspection

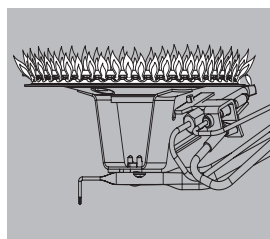

Proper burner and pilot burner pattern.

Visually inspect the pilot burner and main burners annually.

Through the sight glass, inspect the pilot burner flame with the main burner off and inspect the main burner while firing.

If any unusual burner operation is noted, the water heater should be shut off until qualified service assistance can be obtained.

▲CAUTION: For your safety, cleaning of the burner must be performed only by qualified service personnel. The burner chamber is a sealed area. If the burner access door is removed, the burner access door gasket must be replaced.

For cleaning, remove the burner from the water heater. A vacuum cleaner can be used on the burner and floor shield inside the water heater. The burner can also be cleaned by scrubbing with mild detergent.

Vacation and Extended Shut-Down

NOTICE: Refer to the Hydrogen Gas Caution in the Operating Instructions.

If the water heater is to remain idle for an extended period of time, the gas and water to the appliance should be turned off to conserve energy and prevent a build-up of dangerous hydrogen gas.

The water heater and piping should be drained if they might be subjected to freezing temperatures.

After a long shut-down period, the water heater's operation and controls should be checked by qualified service personnel. Make certain the water heater is completely filled again before placing it in operation.

NOTICE: DO NOT remove the anode rod from the water heater's tank, except for inspection and/or replacement, as operation with the anode rod removed will greatly shorten the life of the glass lined tank and will exclude warranty coverage.

Anode Rod

This water heater is equipped with an anode rod designed to prolong the life of the glass lined tank. The anode rod is slowly consumed, thereby eliminating or minimizing corrosion of the glass lined tank.

Water sometimes contains a high sulfate and/or mineral content and together with cathodic protection process can produce a hydrogen sulfide, or rotten egg odor in the heated water. Chlorination of the water supply should minimize the problem.

Before You Call For Service



Troubleshooting Tips

Save time and money! Review the charts on the following pages first and you may not need to call for service.

This water heater incorporates a combustion shut off device that shuts the operation of the water heater down if undesirable combustion conditions occur. Such as the presence of flammable vapors or blockage of the combustion air inlet openings. Please contact a Qualified Service Technician if this occurs.

Problem	Possible Causes	What To Do
Condensation	This usually happens when a new water heater is filled for the first time.	<ul style="list-style-type: none"> This is normal. After the water in the tank warms up, the condensation will disappear. If, however, the condition persists, examine the piping and fittings for possible leaks.
	Moisture from the products of combustion condensing on the tank surface.	<ul style="list-style-type: none"> This is normal and will disappear in time. Excessive condensation can cause pilot burner outage.
	An undersized water heater will cause condensation.	<ul style="list-style-type: none"> Use a water heater size that meets the requirements of your needs.
Yellow flame or soot	Scale on top of the burner.	<ul style="list-style-type: none"> Contact a qualified service technician to remove scale.
	Vent System or Combustion air inlet openings are restricted.	<ul style="list-style-type: none"> Remove obstruction or debris from flue or combustion air inlet openings on water heater jacket.
	Not enough combustion or ventilation air supplied to the water heater location.	<ul style="list-style-type: none"> Proper operation of the water heater requires air for combustion and ventilation. See the Combustion and Ventilation Air information in the “Installing The Water Heater” section of this manual.
	Improper fuel or fuel conversion	<ul style="list-style-type: none"> Check fuel type and Contact a qualified service technician to specify fuel type.
Unable to light the pilot burner	Air in gas line.	<ul style="list-style-type: none"> Contact a qualified service technician to purge the air from the gas line.
	Pilot burner orifice clogged.	<ul style="list-style-type: none"> The pilot burner should be cleaned or replaced by a qualified service technician.
	Pilot burner tube pinched or clogged.	<ul style="list-style-type: none"> The pilot burner should be cleaned, repaired or replaced by a qualified service technician.
	Gas Control Knob not correctly positioned.	<ul style="list-style-type: none"> See the “Lighting The Water Heater” section of this manual.
Pilot burner does not stay lit when the RED button is released	Loose thermocouple.	<ul style="list-style-type: none"> The connection at the gas control (thermostat) should be tightened by a qualified service technician.
	Thermocouple defective.	<ul style="list-style-type: none"> The thermocouple should be replaced by a qualified service technician.
	Safety magnet defective.	<ul style="list-style-type: none"> The gas control (thermostat) should be replaced by a qualified service technician.
	Gas Control (Thermostat’s) single use gas shut-off device has opened.	<ul style="list-style-type: none"> The gas control (thermostat) should be replaced by a qualified service technician.
	Combustion Shutoff Device Tripped.	<ul style="list-style-type: none"> The combustion shutoff device should be inspected by a qualified service technician.

⚠ CAUTION: For your safety **DO NOT** attempt repair of gas piping, gas control (thermostat), burners, vent system or other safety devices. Refer repairs to qualified service personnel.

Before You Call For Service



Troubleshooting Tips

Save time and money! Review the charts on the following pages first and you may not need to call for service.

This water heater incorporates a combustion shut off device that shuts the operation of the water heater down if undesirable combustion conditions occur. Such as the presence of flammable vapors or blockage of the combustion air inlet openings. Please contact a Qualified Service Technician if this occurs.

Problem	Possible Causes	What To Do
Rumbling noise	Scale and sediment	<ul style="list-style-type: none"> ● Drain the water heater to remove scale and sediment from the tank.
Relief valve producing popping noise or draining	Pressure build up caused by thermal expansion to a closed system.	<ul style="list-style-type: none"> ● This is an unacceptable condition and must be corrected. Contact the water supplier or plumbing contractor on how to correct this. Do not plug the relief valve outlet.
Not enough or no hot water	Water usage may have exceeded the capacity of the water heater.	<ul style="list-style-type: none"> ● Wait for the water heater to recover after an abnormal demand.
	Low gas pressure.	<ul style="list-style-type: none"> ● Check gas supply pressure and manifold pressure.
	The pilot burner may be out.	<ul style="list-style-type: none"> ● Check the pilot burner. If necessary, relight using the instructions in the “Lighting The Water Heater” section of this manual.
	The gas control (thermostat) may be set too low.	<ul style="list-style-type: none"> ● See the “Water Temperature Setting” of The Water Heater section of this manual.
	Leaking or open hot water faucets.	<ul style="list-style-type: none"> ● Make sure all faucets are closed.
	Cold water inlet temperature may be colder during the winter months.	<ul style="list-style-type: none"> ● This is normal. The colder inlet water takes longer to heat.
Water is too hot	Combustion Shutoff System tripped	<ul style="list-style-type: none"> ● Contact a qualified service technician.
	The gas control (thermostat) is set too high.	<ul style="list-style-type: none"> ● See the “Water Temperature Setting” of The Water Heater section of this manual.
Pilot Burner Lights, but Main Burner will not stay lit.	Gas Control (Thermostat)	<ul style="list-style-type: none"> ● Contact a qualified service technician to replace the defective gas control (thermostat).
	Combustion Shutoff System tripped.	<ul style="list-style-type: none"> ● Contact a qualified service technician.

⚠ CAUTION: For your safety DO NOT attempt repair of gas piping, gas control (thermostat), burners, vent system or other safety devices. Refer repairs to qualified service personnel.

Replacement Parts

Instructions For Placing a Parts Order

All parts orders should include:

- 1 The model and serial number of the water heater from the rating plate.
- 2 Specify type of gas (natural or LP) as marked on the rating plate.
- 3 Part description (as noted below) and number of parts desired.

⚠ CAUTION: For your safety, **DO NOT attempt repair of gas piping, gas control (thermostat), burners, vent system or other safety devices. Refer repairs to qualified service personnel.**

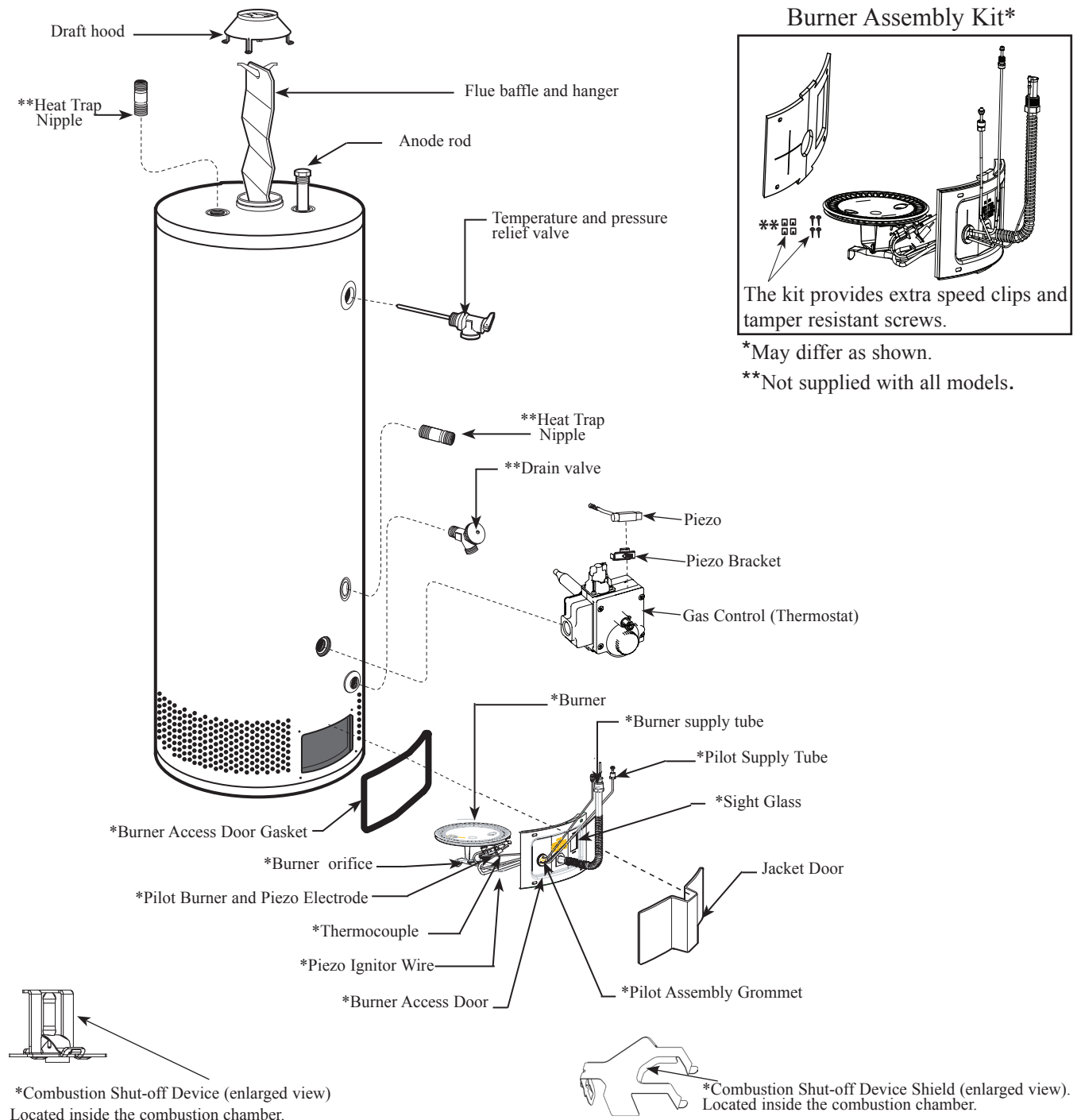

Conversion instructions—Natural Gas to LP Gas

If your gas supply is LP gas, your water heater can be converted to burn LP gas as follows:

Natural Gas to Liquefied Petroleum (LP or Propane) Gas

▲WARNING: This conversion kit must be installed by a qualified installer or service technician in accordance with these instructions. Installation must conform with local codes, or in their absence, with the latest edition of the National Fuel Gas Code, ANSI Z223.1/NFPA 54. Failure to follow instructions could result in serious injury or property damage. The qualified agency performing this work assumes responsibility for this conversion.

▲CAUTION: The water heater is factory set to burn natural gas, but can be converted to burn LP gas. Before placing the water heater into operation, verify that the type of gas supplied to your water heater and the type of gas your water heater is set to burn are the same. If they are not, refer to these instructions.

NOTICE: The parts required to make this conversion are supplied in a bag attached to the water heater. Should your heater not have this bag attached to the water heater, a replacement can be obtained. Simply contact the manufacturer at the address below and request a replacement conversion kit.

Customer Service Department
1241 Carwood Court
Montgomery, AL 36117
Phone: 1-866-279-4566

Tools Required:

- #20 Torx Wrench (Included)
- #2 Phillips Screwdriver
- 3/4" Wrench
- 7/16" Wrench
- 3/8" Wrench
- 5/16" Wrench

- 1 Turn manual gas shut off valve to the OFF position to shutoff gas to the gas control (thermostat).
- 2 Set the gas control (thermostat) dial to the lowest setting by turning the gas control (thermostat) dial clockwise until it stops. **DO NOT FORCE.**
- 3 Slightly depress the gas control knob and turn clockwise to "OFF" position. **NOTICE:** Knob cannot be turned from "PILOT" position unless pushed down slightly. **DO NOT USE FORCE.**
- 4 Change gas regulators setting by removing cover from the gas selector screw; then remove and reinstall the selector screw with the red washer and LP arrow pointing inward toward the heater. Tighten to 4-8 in•lb. Replace cover.

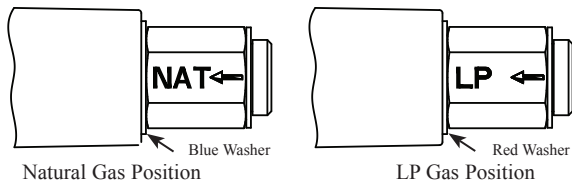

Gas Selector Screw Settings

Front View of Gas Control (Thermostat)

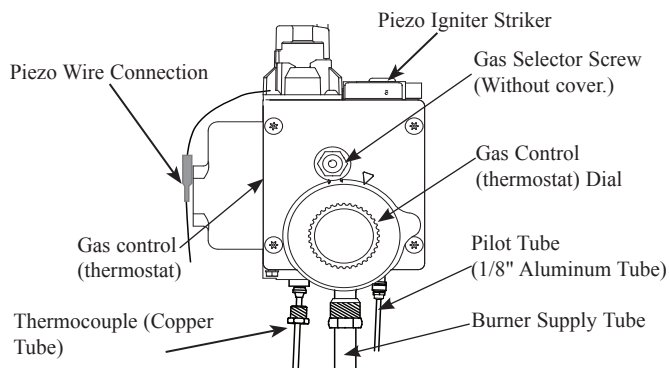

- 5 Remove outer jacket door.

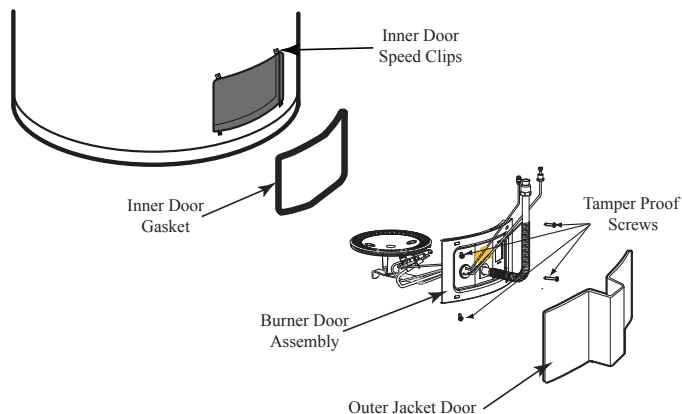

- 6 Remove the four screws on the inner door using the #20 TORX wrench supplied with the conversion kit. Disconnect burner supply tube using the 3/4" wrench, pilot tube using the 7/16" wrench, and thermocouple using the 3/8" wrench from the gas control (thermostat). Disconnect the piezo wire from piezo ignitor striker connection. Remove the entire burner assembly along with the inner door.

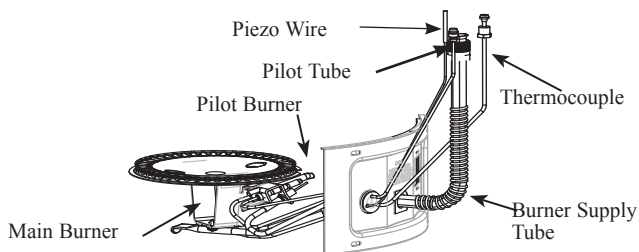

- 7 Remove the Philips head screw that holds the pilot burner assembly in place. Remove the pilot burner assembly from the burner bracket. Remove the two #6 x 3/8" long Philips head screws from the burner bracket and remove the burner from inner door assembly to expose main burner orifice.

Conversion Instructions—Natural Gas to LP Gas

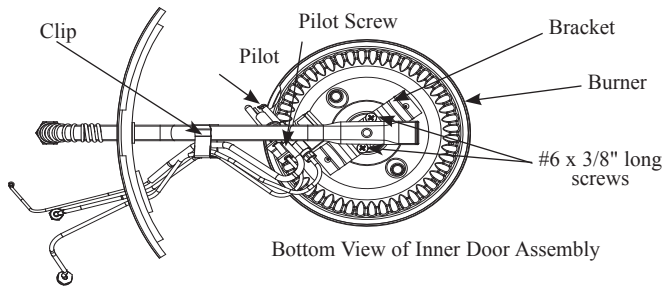

Bottom View of Inner Door Assembly

- 8** Remove main burner orifice. Replace main burner natural gas orifice with the Red colored main burner orifice (stamped LP) supplied in the bag.

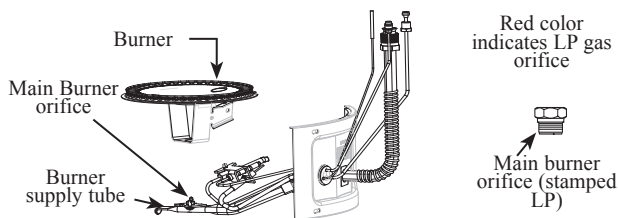

- 9** Remove the compression nut from the pilot burner assembly using the 3/8 in. and 5/16 in. wrench to expose pilot burner orifice. Remove natural gas pilot burner orifice and replace with Yellow marked LP pilot burner orifice supplied in the package. Replace the compression nut on pilot burner assembly and tighten the nut.

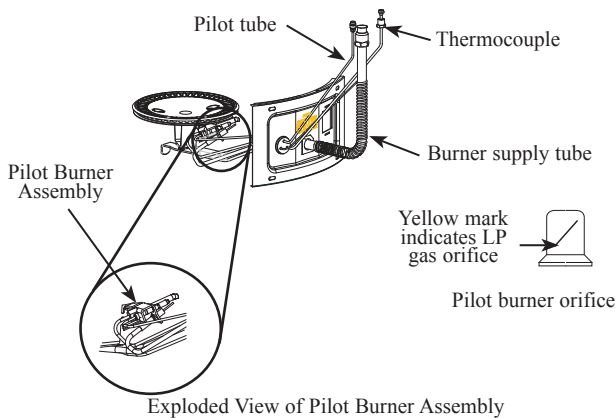

Exploded View of Pilot Burner Assembly

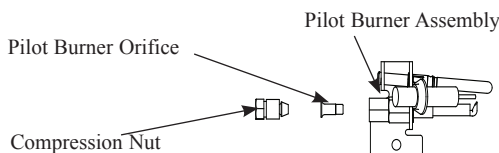

- 10** Replace main burner (Natural gas) with the (Red) colored (LP) main burner supplied in the package. Reinstall the two #6 x 3/8 in. long Phillips head screws. Screw the pilot burner assembly to the burner bracket using the Phillips head screw removed on step

7.

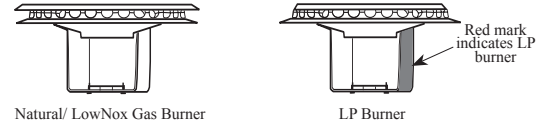

- 11** Remove the gasket from inner door. Clean the metal surfaces to assure good adhesion of new gasket (supplied in bag) to the inner door. Align screw holes of new gasket with holes on inner door and press gasket firmly in place.
- 12** Reinstall entire inner door assembly to the heater. Ensure the speed clips are in place and the gasket is fully sealed. Attach inner door loosely to the heater using four #20 TORX screws. Reconnect and tighten burner supply, pilot tube and thermocouple at the thermostat. Handle tubes carefully to avoid damaging them. **DO NOT** over-tighten or cross-thread the connections. Now tighten the four #20 TORX screws to secure the inner door firmly to the heater. Reconnect the piezo wire to the piezo ignitor striker connection.
- 13** Attach green **CAUTION** label from the bag to the outside of the water heater near the gas control. Label should be signed by qualified installer or service organization
- 14** Return the unused parts to the bag for possible future conversions. Return the bag and this Use and Care manual to the plastic bag attached to the water heater.
- 15** Install outer jacket door to heater.
- 16** Turn manual gas shut off valve to the ON position to start gas flow to the thermostat. Leak test all gas connections and caps with soap/water solution. Bubbles indicate a leak. Make certain all leaks have been repaired, and the outer jacket door has been replaced.
- 17** Follow lighting instructions on page 15 of the manual to start the water heater.

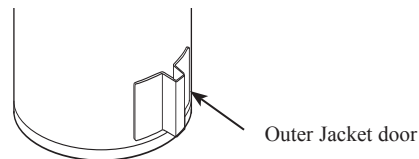

Outer Jacket door

Conversion instructions—LP Gas to Natural Gas

Your water heater was factory pre-set to burn natural gas but may have been converted to burn LP gas. If your water heater has been converted to burn LP Gas, and your gas supply is now natural gas, your water heater can be converted to burn natural gas as follows:

Liquefied Petroleum (LP or Propane) to Gas Natural Gas

⚠ WARNING: This conversion kit must be installed by a qualified installer or service technician in accordance with these instructions. Installation must conform with local codes, or in their absence, with the latest edition of the National Fuel Gas Code, ANSI Z223.1/NFPA 54. Failure to follow instructions could result in serious injury or property damage. The qualified agency performing this work assumes responsibility for this conversion.

⚠ CAUTION: The water heater is factory set to burn natural gas, but can be converted to burn LP gas. Before placing the water heater into operation, verify that the type of gas supplied to your water heater and the type of gas your water heater is set to burn are the same. If they are not, refer to these instructions.

NOTICE: The parts required to make this conversion are supplied in a bag attached to the water heater. Should your heater not have this bag attached to the water heater, a replacement can be obtained. Simply contact the manufacturer at the address below and request a replacement conversion kit.

Customer Service Department
1241 Carwood Court
Montgomery, AL 36117
Phone: 1-866-279-4566

Tools Required:

- #20 Torx Wrench (Included)
- #2 Phillips Screwdriver
- 3/4" Wrench
- 7/16" Wrench
- 3/8" Wrench
- 5/16" Wrench

- 1 Turn manual gas shut off valve to the OFF position to shutoff gas to the thermostat.
- 2 Set the thermostat dial to the lowest setting by turning the thermostat dial clockwise until it stops. **DO NOT FORCE.**
- 3 Slightly depress the gas control knob and turn clockwise to "OFF" position. **NOTICE:** Knob cannot be turned from "PILOT" position unless pushed down slightly. **DO NOT USE FORCE.**



- 4 Change gas regulator setting by removing cover from the gas selector screw; then remove and reinstall the selector screw with the blue washer and NAT arrow mark pointing inward toward the heater. Tighten to 4-8 in•lb. Replace cover.

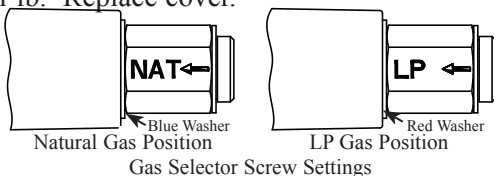

Front View of Gas Thermostat

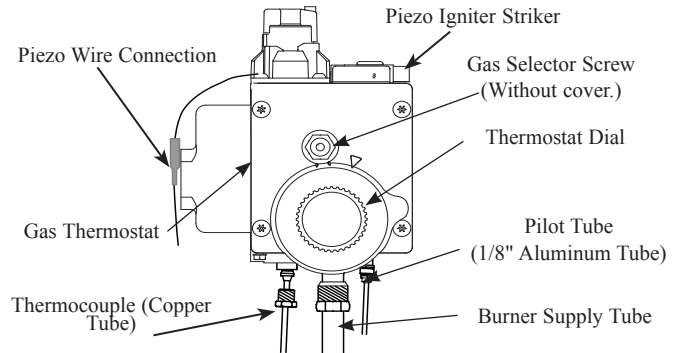

- 5 Remove outer jacket door.

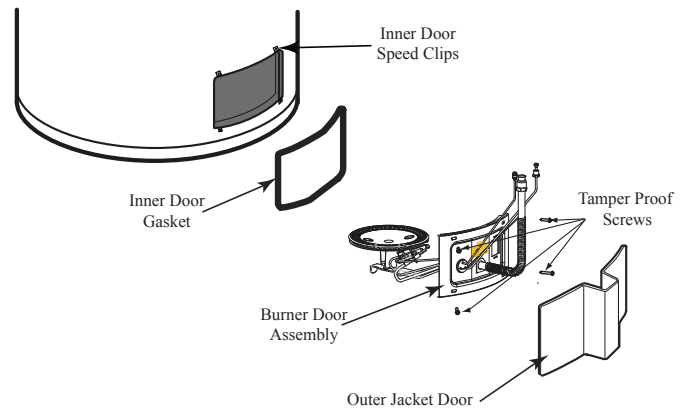

- 6 Remove the four screws on the inner door using the #20 TORX wrench supplied with the conversion kit. Disconnect burner supply tube using the 3/4 in. wrench, pilot tube using the 7/16 in. wrench, and thermocouple using the 3/8 in. wrench from the thermostat. Disconnect the piezo wire from piezo igniter striker connection. Remove the entire burner assembly along with the inner door.

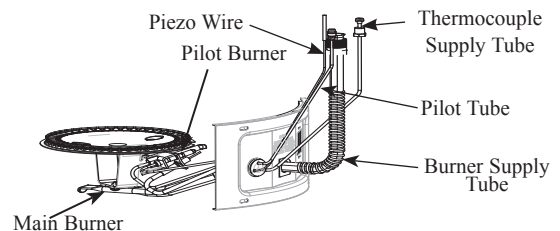

- 7 Remove the Philips head screw that holds the pilot burner assembly in place. Remove the pilot burner assembly from the burner bracket. Remove the two #6 x 3/8 in. long Philips head screws from the burner bracket and remove the burner from inner door assembly to expose main burner orifice.

Conversion instructions—LP Gas to Natural Gas

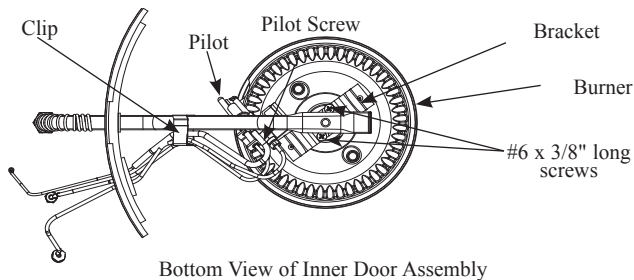

Bottom View of Inner Door Assembly

- 8** Remove LP burner orifice. Replace Red marked LP gas burner orifice with the main burner orifice stamped NG supplied in the bag.

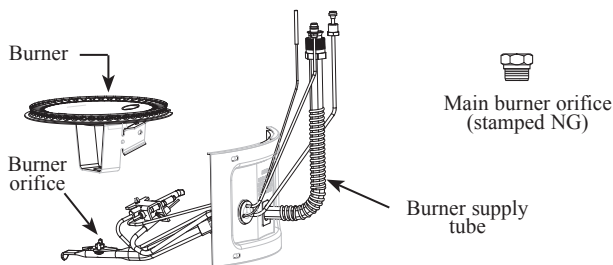

- 9** Remove the compression nut from the pilot burner assembly using the 3/8 in. and 5/16 in. wrench to expose pilot burner orifice. Remove the yellow marked LP gas pilot burner orifice and replace with natural gas pilot burner orifice supplied in the package. Replace the compression nut on pilot burner assembly and tighten the nut.

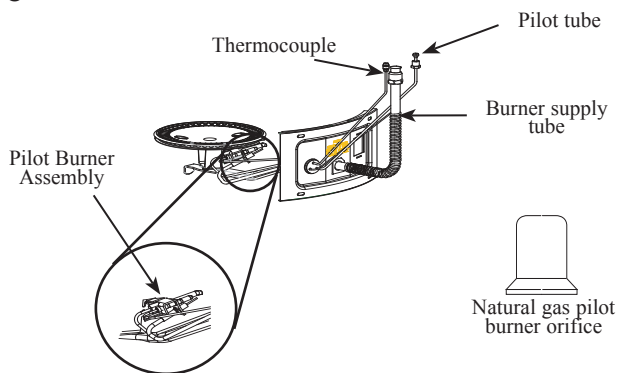

Exploded View of Pilot Burner Assembly

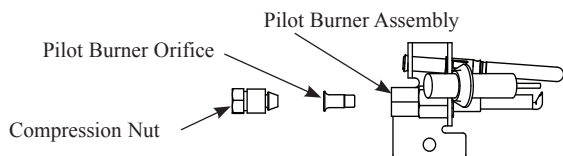

- 10** Replace Red marked (LP) main burner with the main burner (Natural gas) supplied in the package. Reinstall the two #6 x 3/8 in. long Phillips head screws. Screw the pilot burner assembly to the burner bracket using the Phillips head screw removed on step 7.

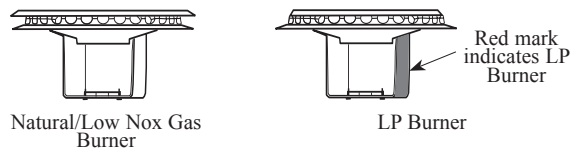

- 11** Remove the gasket from inner door. Clean the metal surfaces to assure good adhesion of new gasket to the inner door. Align screw holes of new gasket with holes on inner door and press gasket firmly in place.
- 12** Reinstall entire inner door assembly to the heater. Ensure the speed clips are in place and the gasket is fully sealed. Attach inner door loosely to the heater using four #20 TORX screws. Reconnect and tighten burner supply, pilot tube and thermocouple at the thermostat. Handle tubes carefully to avoid damaging them. **DO NOT** over-tighten or cross-thread the connections. Now tighten the four #20 TORX screws to secure the inner door firmly to the heater. Reconnect the piezo wire to the piezo ignitor striker connection.
- 13** Attach green CAUTION label from the bag to the outside of the water heater near the gas control. Label should be signed by qualified installer or service organization
- 14** Return the unused parts to the bag for possible future conversions. Return the bag and this Use and Care manual to the plastic bag attached to the water heater.
- 15** Install outer jacket door to heater.

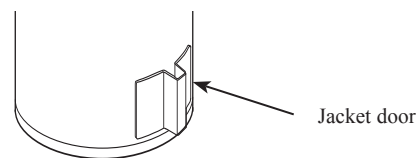

- 16** Turn manual gas shut off valve to the ON position to start gas flow to the thermostat. Leak test all gas connections and caps with soap/water solution. Bubbles indicate a leak. Make certain all leaks have been repaired, and the outer jacket door has been replaced.
- 17** Follow lighting instructions on page 15 of the manual to start the heater.

NOTES:

IF YOU NEED SERVICE



1. Should you have any questions about your new water heater, or if it requires adjustment, repair, or routine maintenance, it is suggested that you first contact your installer, plumbing contractor or previously agreed upon service agency. In the event the firm has moved, or is unavailable, refer to the telephone directory, commercial listings or local utility for qualified service assistance.

2. Should your problem not be solved to your complete satisfaction, you should then contact the Manufacturer's National Service Department at the following address:

1241 Carwood Court
Montgomery, Alabama 36117
Phone: 1-866-279-4566.

When contacting the manufacturer, the following information will be requested:

- a. Model and serial number of the water heater as shown on the rating plate attached to the jacket of the heater.
- b. Address where the water heater is located and physical location.
- c. Name and address of installer and any service agency who performed service on the water heater.
- d. Date of original installation and dates any service work was performed.
- e. Details of the problems as you can best describe them.
- f. List of people, with dates, who have been contacted regarding your problem.